

# QRM-NV series

Ø8 and Ø14 mm rear panel mount •  
NVIS LED indicators



## DISTINCTIVE FEATURES

NVIS Green A, NVIS Green B, NVIS Yellow, NVIS Red, NVIS White  
NVIS compliant to MIL Std 3009

200 mm wire for Ø 8 and 14 mm or rigid pin (1.00 mm) for Ø8 mm terminations



## ENVIRONMENTAL SPECIFICATIONS

- IP67 sealing option (EN60529)
- Operating Temperature Range: -40 °C to +85 °C (-40 °F to +185 °F)
- Storage Temperature Range: -55 °C to +100 °C (-67 °F to +212 °F)



## GENERAL SPECIFICATIONS

- Max Reverse Voltage: 5 V
- Viewing Angle: 60°
- Life Expectancy: 100,000 hours
- Max Panel Thickness: 3.5 mm
- Torque: **Ø8 mm:** 60 cNm  
**Ø14 mm:** 75 cNm
- Insulation resistance : 4,000 MΩ at 500 VDC



## ELECTRICAL SPECIFICATIONS

Voltage	Operating Voltage	Operating Current
	(Min to Max)	(Typical All Types)
02 (No Resistor)	2.1 to 3.3 VDC	20 mA max
6 VDC	5.4 to 6.6 VDC	20 mA
12 VDC	10.8 to 13.2 VDC	20 mA
24 VDC	21.6 to 26.4 VDC	20 mA
28 VDC	25.2 to 30.8 VDC	20 mA

The company reserves the right to change specifications without notice.

LED characteristics are dependent upon environmental conditions. Therefore published data should be considered nominal and subject to variations.



# QRM-NV series

Ø8 and Ø14 mm rear panel mount •  
NVIS LED indicators

## ELECTRICAL SPECIFICATIONS (CONTINUED)

LED COMPONENT SPECIFICATIONS

LED Color	NVIS Radiance	NVIS Chromaticity	Dominant Wavelength	MCD Output	Forward Voltage
NVIS Green A	$NRA \leq 1.7eE-10 @ 0.1fL$	$r \leq .037$	530 nm	150 mcd	3.3 V
NVIS Green B	$NRA \leq 1.7eE-10 @ 0.1fL$	$r \leq .057$	555 nm	150 mcd	3.3 V
NVIS Yellow Class A	$5.0E-8 \leq NRA \leq 1.5E-7 @ 15fL$	$r \leq .083$	-	150 mcd	3.3V
NVIS Yellow Class B	$4.7E-8 \leq NRB \leq 1.47E-7 @ 15fL$	$r \leq 0.83$	585 nm	150 mcd	3.3 V
NVIS Red	$4.7E-8 \leq NRB \leq 1.4E-7 @ 15 fL$	$r \leq .060$	605 nm	110 mcd	2.1 V
NVIS White	$NRA \leq 1.0E-9 @ 0.1fL$	$r \leq .40$	(x).33 (y).33	150 mcd	3.3 V

- The operating voltage must not be exceeded by more that 10% as this will result in reduced life expectancy
- Luminous intensity is measured at 20 mA on a discrete led unless otherwise stated.
- Luminous intensities and color shades of white LEDs may vary within a batch.
- Luminous intensity will be reduced with lower operating current.

## MATERIALS

- Body: Black plated brass or anodized aluminum
- Lock Washer: Spring steel
- Nut: Black plated brass
- Terminal Seal: Epoxy
- Panel Seal: Nitrile O-ring
- Wires: **Ø8 mm:** 24 AWG - Approved to UL1213  
**Ø14 mm:** 22A WG - Approved to UL1007

## MOUNTING

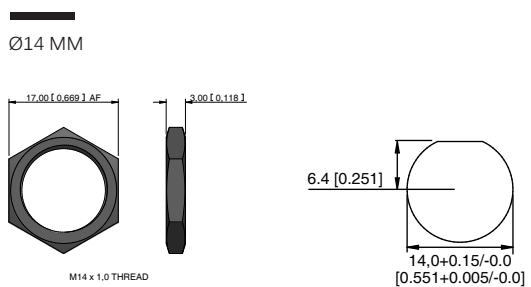
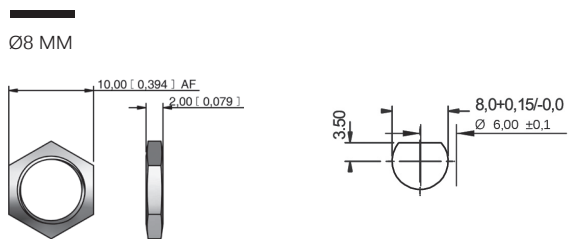

# QRM-NV series

Ø8 and Ø14 mm rear panel mount • NVIS LED indicators



## BUILD YOUR PART NUMBER

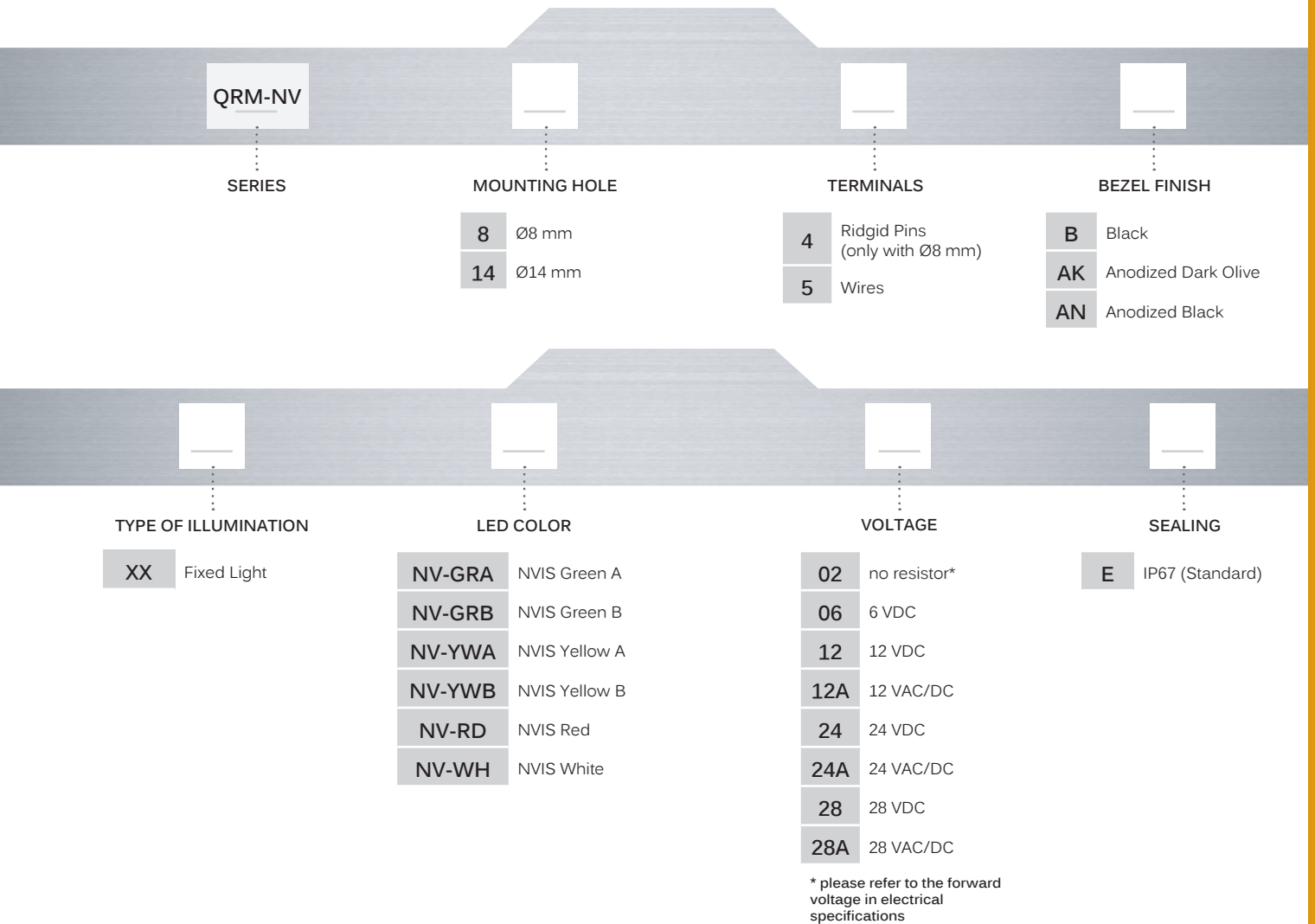

## ABOUT THIS SERIES

- ⚠ **Notice:** please note that not all combinations of above numbers are available.
- Standard wire length is 200 mm, 24 AWG UL1061, red wire denotes Anode (+), black wire denotes Cathode (-) for other wire lengths consult APEM.
  - For LEDs with alternate voltages and multi-voltage options consult APEM.
  - Take care when soldering (recommended solder temperature 270°C - 2 sec).
  - Suitable for the toughest environment and compliant to MIL standard specification

# QRM-NV series

Ø8 and Ø14 mm rear panel mount •  
NVIS LED indicators

## Ø8 MM REAR MOUNT - PINS TERMINALS

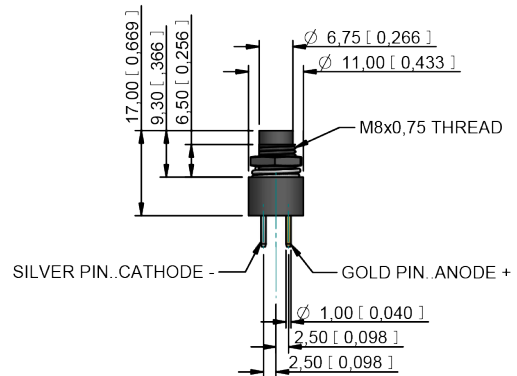

## Ø8 MM REAR MOUNT - WIRES TERMINALS

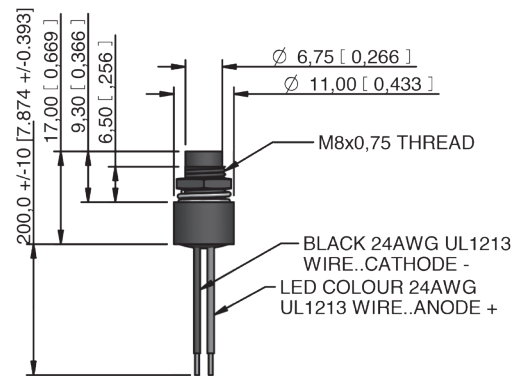

## Ø14 MM REAR MOUNT - WIRES TERMINALS

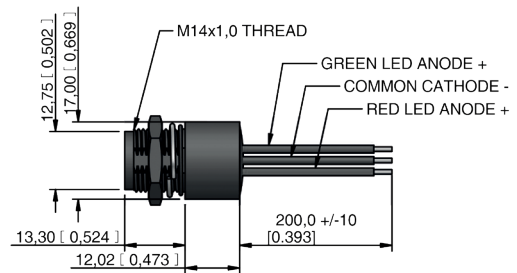

## HARDWARE - CYLINDRICAL DRESS NUTS - FOR Ø8 MM ONLY



P/N : AUK0001

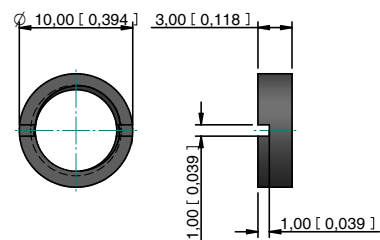

# QRM-NV series

Ø8 and Ø14 mm rear panel mount •  
NVIS LED indicators

HARDWARE - KNURLED DRESS NUTS  
- FOR Ø8 MM ONLY



P/N : AUK0002

